

Folding-Door

Model 73 Folding door

Frame Assembly and Installation Instructions
001--2024-11-14

INTRODUCTION

These instructions are intended for the installer to quickly summarize the major steps of the installation and provide full detailed instructions. The installer must read the complete instructions in their entirety and rely on this document to understand all warnings, procedures, and standards.



WARNING! Do not lift or move without the proper equipment. Read, understand, and follow all lifting equipment manufacturer's instructions and safety information.

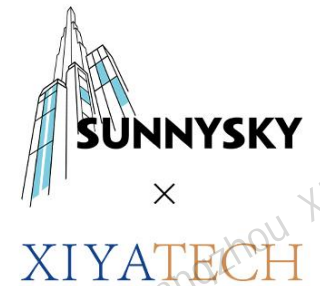

1 Prepare tools



2. Product details

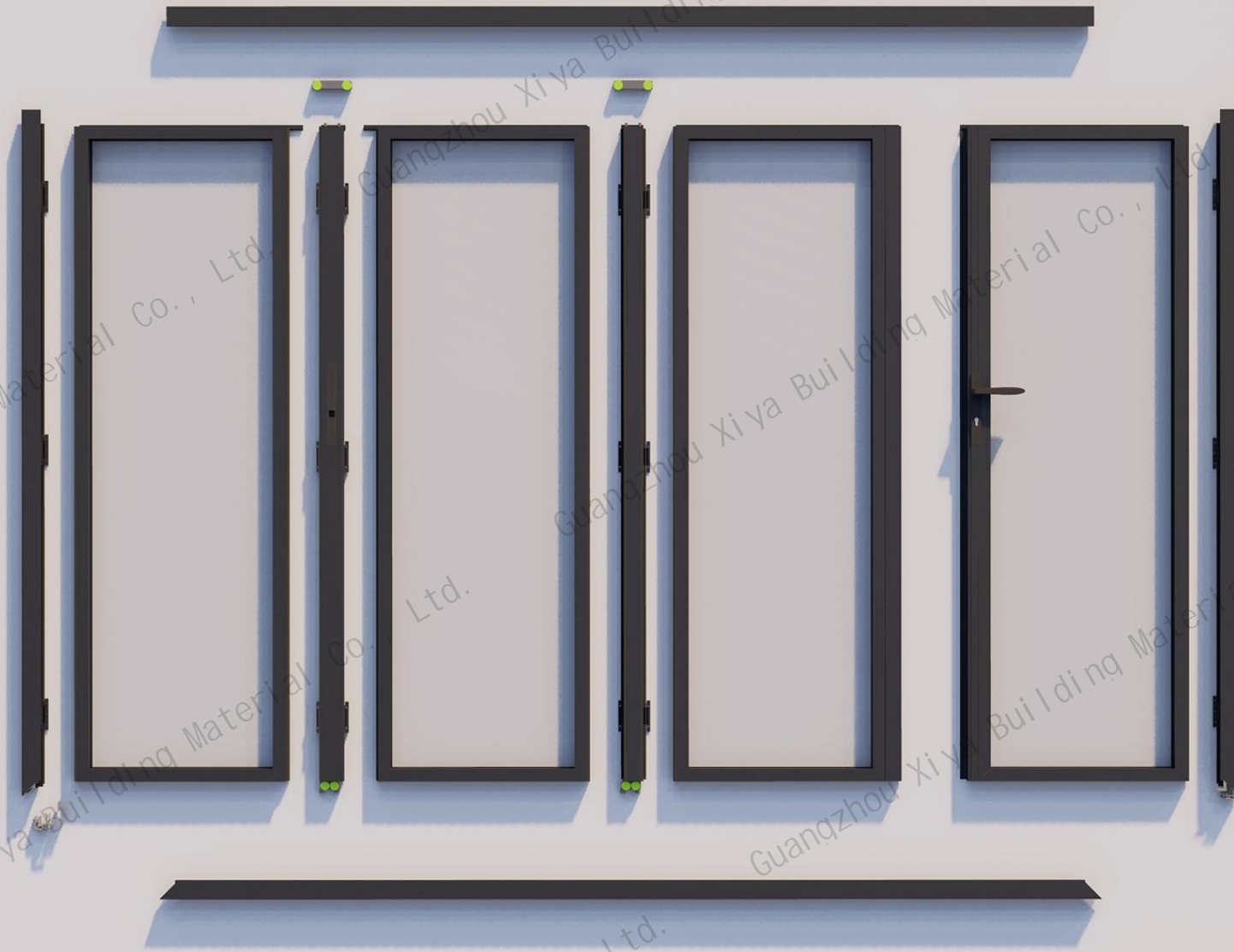

3. Preparatory work for the RO

Ensure that the four sides of the opening are right angles.

Ro Size=Overall Size+1/2"

Use a level to confirm that the window sill is parallel to the floor.



4.1. Assemble the window frame

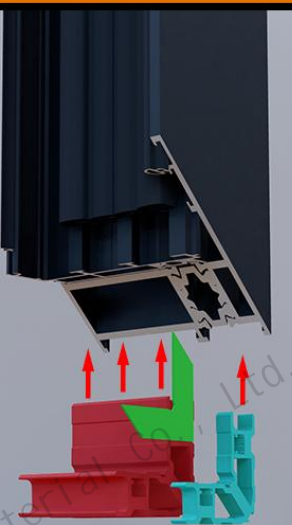

1. Place the corner bracket into the side frame
2. Then install the lower track of the side frame

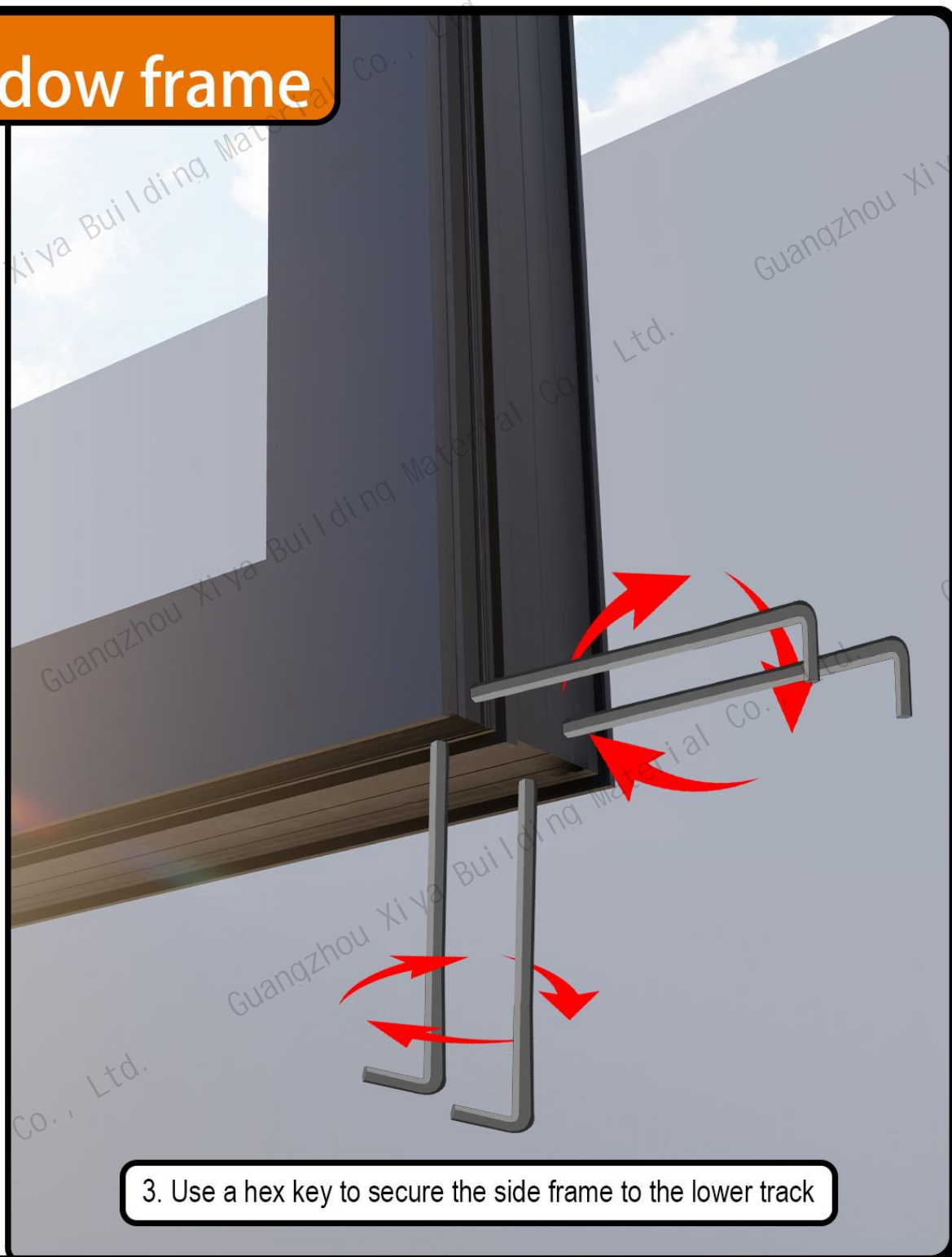
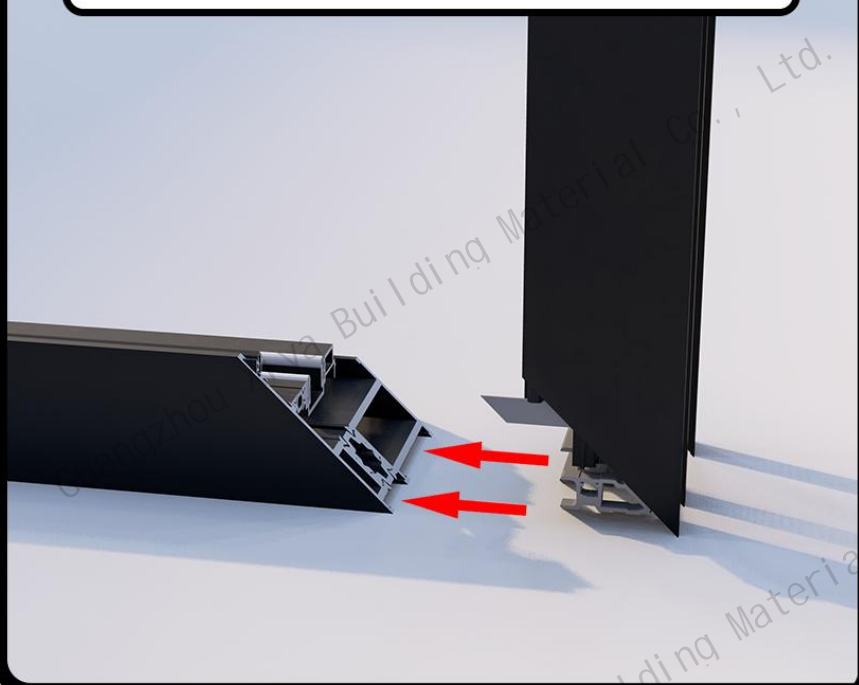

3. Use a hex key to secure the side frame to the lower track

4.2. Assemble the window frame

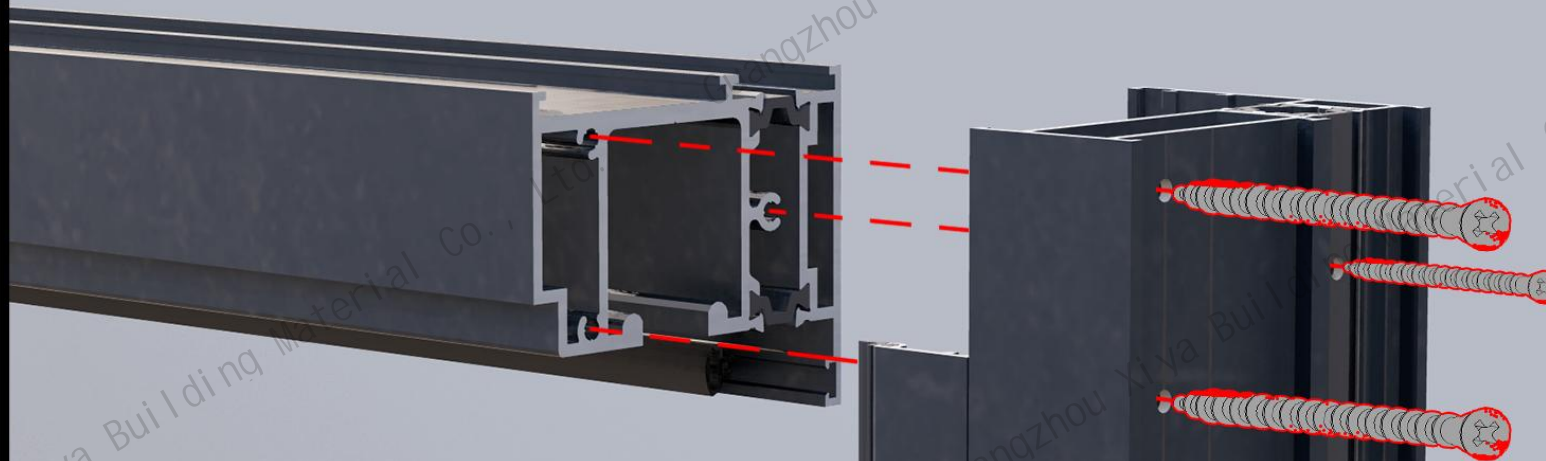

Align the side frame with the top rail and secure it to the top rail using self-tapping screws along the pre-drilled holes

4.3. Assemble the window frame

assemble the four corners

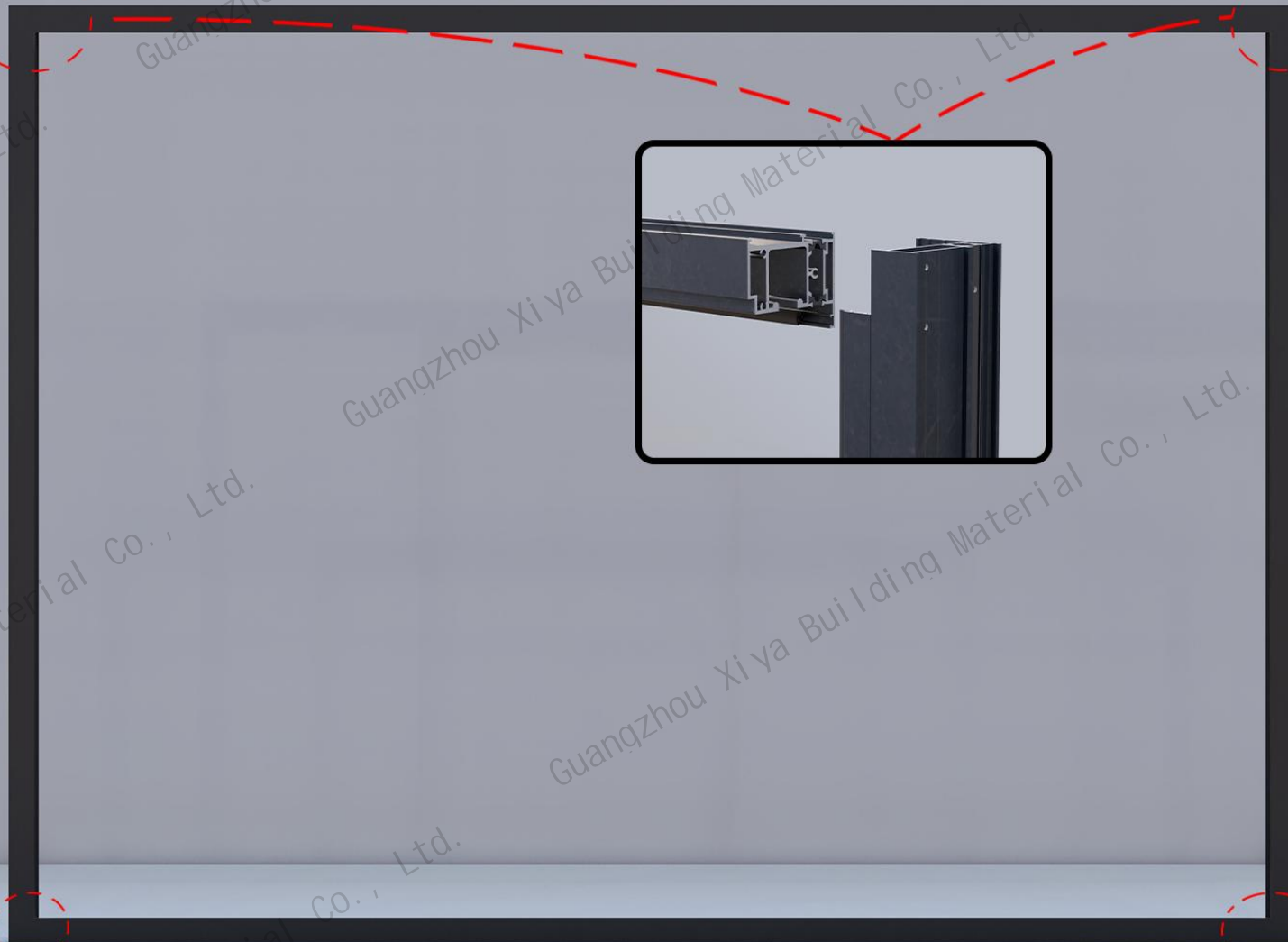
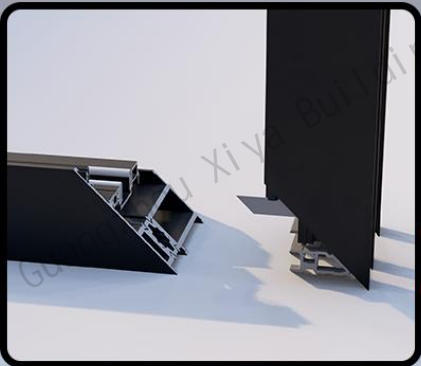

5. Secure the frame

Put the door frame into the opening and adjust it to be level.
If one side is tilted, you can use Shim to adjust it to be level.

Shim

Attention! Before fitting the frame into the installation opening, ensure to distinguish between its interior and exterior sides—note that the water-retaining edge is located on the interior side. The wing is to be installed on the exterior side.

ins

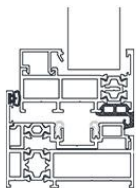

out



6. Install Nail fin (Nail Flange)



Method 1: Nail Flange Installation

Installation of the Nail Flange shall be carried out from the outdoor side.



Install the wing and fix it with screws 12 inches from the edge, then evenly space and secure the middle section with screws.



Use a level meter to check the overall levelness

Method 2: Drilling Installation

Secure the door frame with screws. Fix the frame sides with screws 12 inches from the edge, then evenly space and secure the middle section with screws.

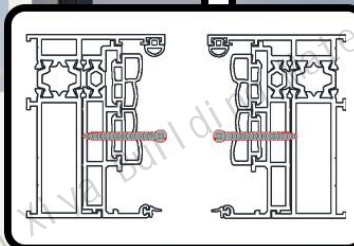
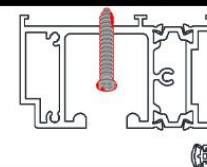

Fix the screw to the groove



Use a level meter to check the overall levelness

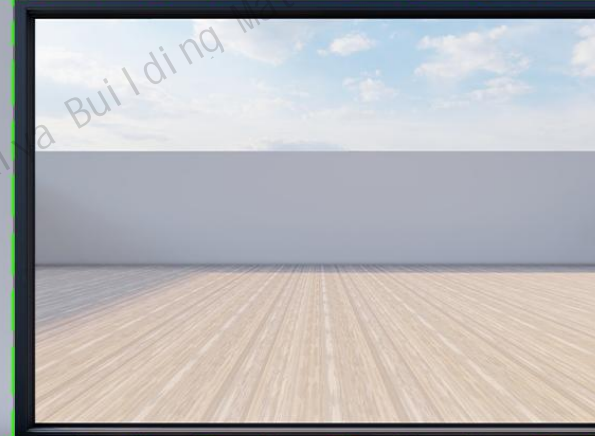

7. Door Leaf Installation

1. First, insert the central column of the folding door panel into the lower track on the installation side



2. Move the hinged door panel into the frame on the installation side, and secure the door panel to the frame using hinges



Align the middle column of the door panel with the upper pulley and insert it. Turn the screws below to secure both sides



Hoist wheel

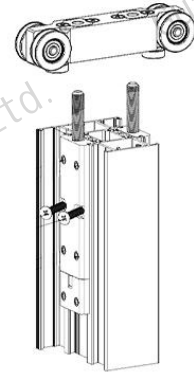

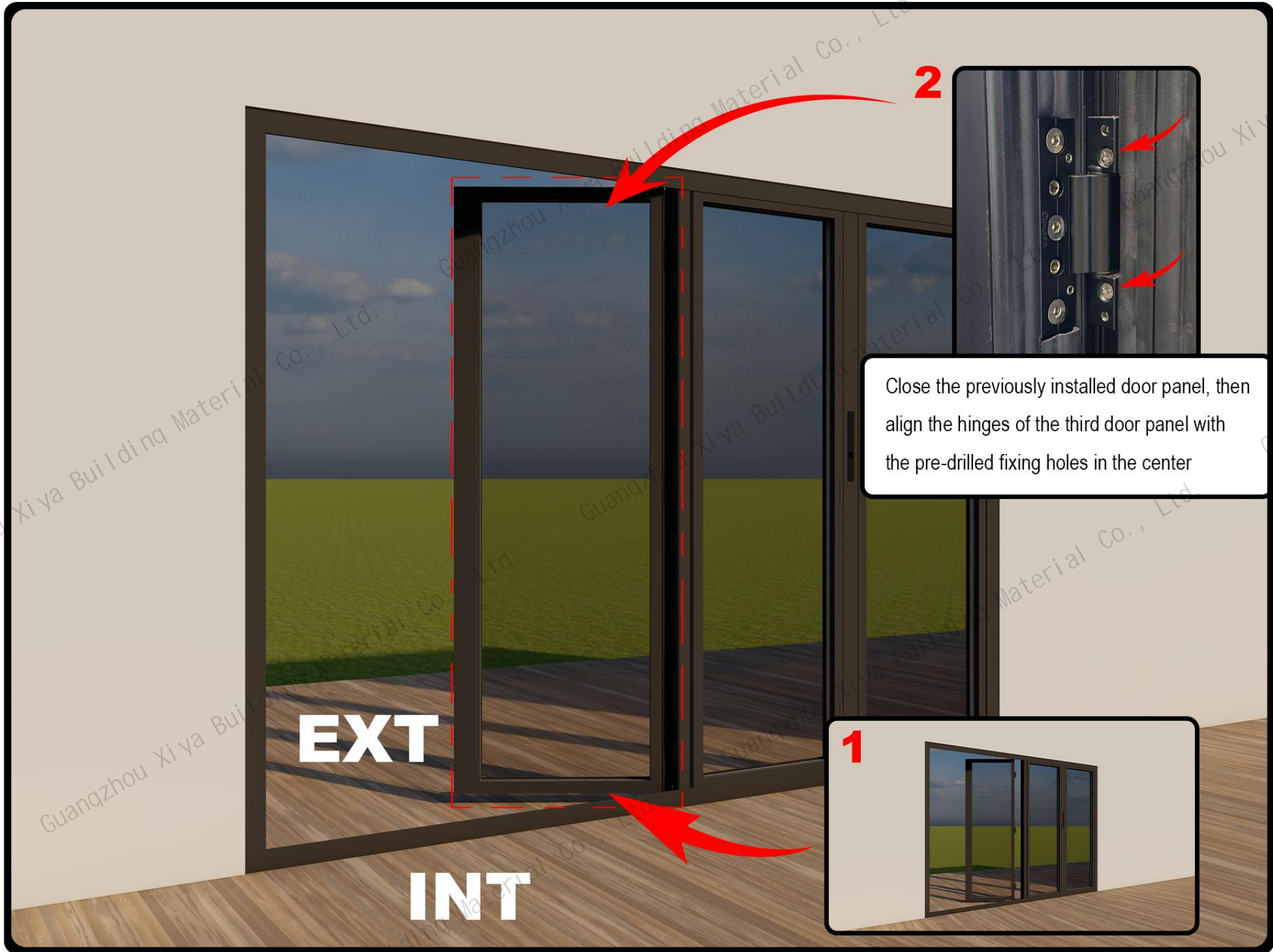

2

Close the previously installed door panel, then align the hinges of the third door panel with the pre-drilled fixing holes in the center

1

EXT

INT

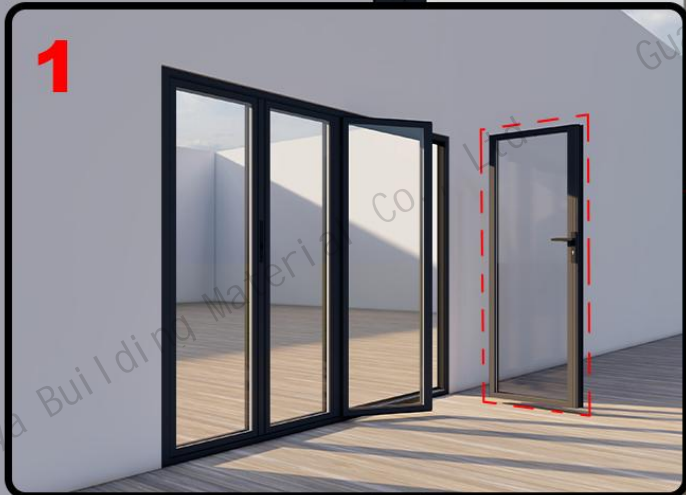

Align the last door panel with the pre-drilled holes on the frame and install the hinges

8. Check door panels for level alignment



Close the door panels and check the vertical and horizontal alignment of each door panel

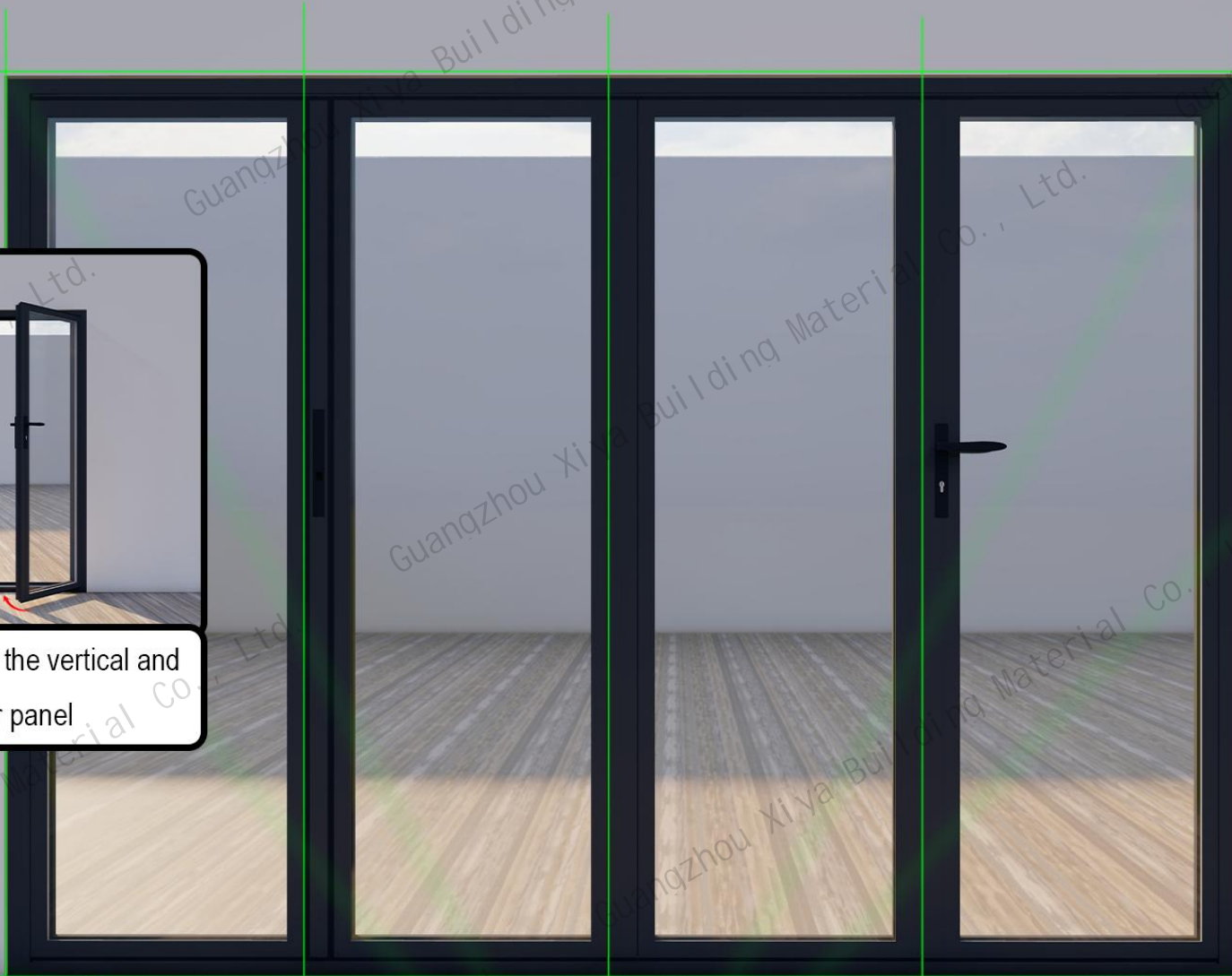

9. Adjust door leaf vertically

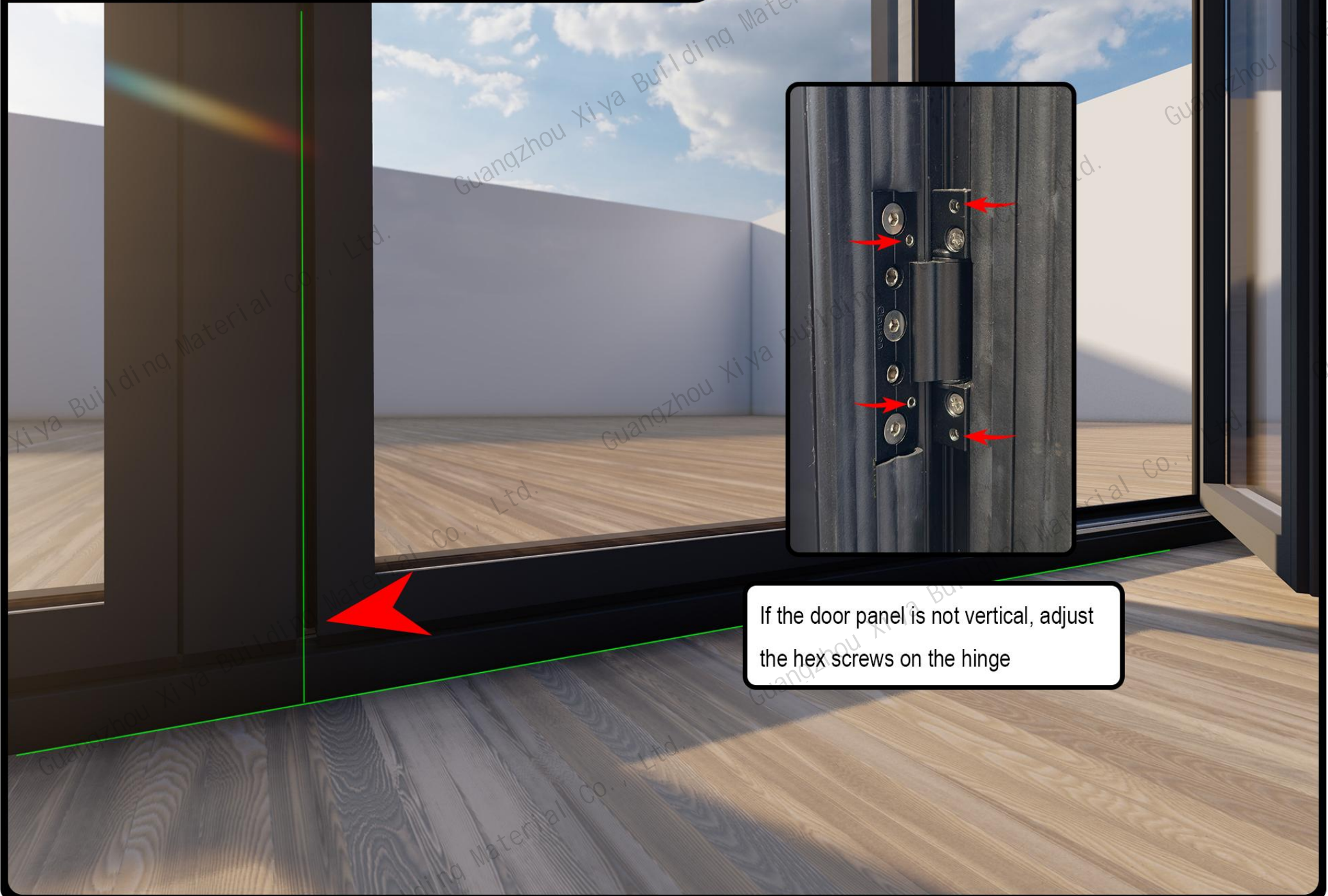

If the door panel is not vertical, adjust the hex screws on the hinge